

LNT9MD34X2,  
LNT9ME34W2,  
LNT9ME34X2



---

EN Fridge Freezer

---

User Manual

# CONTENTS

1. SAFETY INFORMATION.....	3
2. SAFETY INSTRUCTIONS.....	5
3. INSTALLATION.....	7
4. OPERATION.....	10
5. WI-FI CONNECTIVITY SETUP.....	13
6. DAILY USE.....	14
7. HINTS AND TIPS.....	16
8. CARE AND CLEANING.....	19
9. TROUBLESHOOTING.....	19
10. NOISES.....	24
11. TECHNICAL DATA.....	24
12. INFORMATION FOR TEST INSTITUTES.....	24
13. ENVIRONMENTAL CONCERNS.....	25

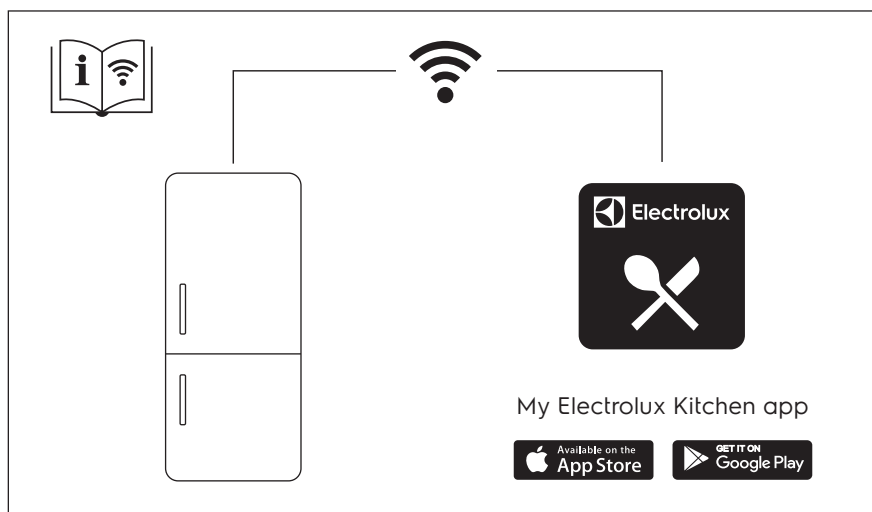

## WE'RE THINKING OF YOU

Thank you for purchasing an Electrolux appliance. You've chosen a product that brings with it decades of professional experience and innovation. Ingenious and stylish, it has been designed with you in mind. So whenever you use it, you can be safe in the knowledge that you'll get great results every time.

Welcome to Electrolux.

**Visit our website to:**



Get usage advice, brochures, trouble shooter, service and repair information:  
**[www.electrolux.com/support](http://www.electrolux.com/support)**



Register your product for better service:  
**[www.registerelectrolux.com](http://www.registerelectrolux.com)**



Buy Accessories, Consumables and Original spare parts for your appliance:  
**[www.electrolux.com/shop](http://www.electrolux.com/shop)**

## CUSTOMER CARE AND SERVICE

Always use original spare parts.

When contacting our Authorised Service Centre, ensure that you have the following data available: Model, PNC, Serial Number.

The information can be found on the rating plate.

 Warning / Caution-Safety information

 General information and tips

 Environmental information

Subject to change without notice.

### 1. SAFETY INFORMATION

Before the installation and use of the appliance, carefully read the supplied instructions. The manufacturer is not responsible for any injuries or damage that are the result of incorrect installation or usage. Always keep the instructions in a safe and accessible location for future reference.

#### 1.1 Children and vulnerable people safety

- This appliance can be used by children aged from 8 years and above and persons with reduced physical, sensory or mental capabilities or lack of experience and knowledge if they have been given supervision or instruction concerning the use of the appliance in a safe way and understand the hazards involved.

- Children aged from 3 to 8 years are allowed to load and unload the appliance provided that they have been properly instructed.
- This appliance may be used by persons with very extensive and complex disabilities provided that they have been properly instructed.
- Children of less than 3 years of age should be kept away from the appliance unless continuously supervised.
- Children should be supervised to ensure that they do not play with the appliance and mobile devices with My Electrolux Kitchen app.
- Children shall not carry out cleaning and user maintenance of the appliance without supervision.
- Keep all packaging away from children and dispose of it appropriately.

## 1.2 General Safety

- This appliance is intended to be used in household and similar applications such as:
  - Farm houses; staff kitchen areas in shops, offices and other working environments;
  - By clients in hotels, motels, bed and breakfast and other residential type environments.
- To avoid contamination of food respect the following instructions:
  - do not open the door for long periods;
  - clean regularly surfaces that can come in contact with food and accessible drainage systems;
  - store raw meat and fish in suitable containers in the refrigerator, so that it is not in contact with or drip onto other food.
- **WARNING:** Keep ventilation openings, in the appliance enclosure or in the built-in structure, clear of obstruction.
- **WARNING:** Do not use mechanical devices or other means to accelerate the defrosting process, other than those recommended by the manufacturer.

- **WARNING:** Do not damage the refrigerant circuit.
- **WARNING:** Do not use electrical appliances inside the food storage compartments of the appliance, unless they are of the type recommended by the manufacturer.
- Do not use water spray and steam to clean the appliance.
- Clean the appliance with a moist soft cloth. Only use neutral detergents. Do not use abrasive products, abrasive cleaning pads, solvents or metal objects.
- When the appliance is empty for long period, switch it off, defrost, clean, dry and leave the door open to prevent mould from developing within the appliance.
- Do not store explosive substances such as aerosol cans with a flammable propellant in this appliance.
- If the supply cord is damaged, it must be replaced by the manufacturer, its Authorised Service Centre or similarly qualified persons in order to avoid a hazard.

## 2. SAFETY INSTRUCTIONS

### 2.1 Installation



#### **WARNING!**

Only a qualified person must install this appliance.

- Remove all the packaging.
- Do not install or use a damaged appliance.
- Follow the installation instructions supplied with the appliance.
- Always take care when moving the appliance as it is heavy. Always use safety gloves and enclosed footwear.
- Make sure the air can circulate around the appliance.
- At first installation or after reversing the door wait at least 4 hours before connecting the appliance to the power supply. This is to allow the oil to flow back in the compressor.
- Before carrying out any operations on the appliance (e.g. reversing the door), remove the plug from the power socket.

- Do not install the appliance close to radiators or cookers, ovens or hobs.
- Do not expose the appliance to the rain.
- Do not install the appliance where there is direct sunlight.
- Do not install this appliance in areas that are too humid or too cold.
- When you move the appliance, lift it by the front edge to avoid scratching the floor.

### 2.2 Electrical connection



#### **WARNING!**

Risk of fire and electric shock.



#### **WARNING!**

When positioning the appliance, ensure the supply cord is not trapped or damaged.

**WARNING!**

Do not use multi-plug adapters and extension cables.

- The appliance must be earthed.
- Make sure that the parameters on the rating plate are compatible with the electrical ratings of the mains power supply.
- Always use a correctly installed shockproof socket.
- Make sure not to cause damage to the electrical components (e.g. mains plug, mains cable, compressor). Contact the Authorised Service Centre or an electrician to change the electrical components.
- The mains cable must stay below the level of the mains plug.
- Connect the mains plug to the mains socket only at the end of the installation. Make sure that there is access to the mains plug after the installation.
- Do not pull the mains cable to disconnect the appliance. Always pull the mains plug.

## 2.3 Use

**WARNING!**

Risk of injury, burns, electric shock or fire.



The appliance contains flammable gas, isobutane (R600a), a natural gas with a high level of environmental compatibility. Be careful not to cause damage to the refrigerant circuit containing isobutane.

- Do not change the specification of this appliance.
- Do not put electrical appliances (e.g. ice cream makers) in the appliance unless they are stated applicable by the manufacturer.
- If damage occurs to the refrigerant circuit, make sure that there are no flames and sources of ignition in the room. Ventilate the room.
- Do not let hot items to touch the plastic parts of the appliance.

- Do not put soft drinks in the freezer compartment. This will create pressure on the drink container.
- Do not store flammable gas and liquid in the appliance.
- Do not put flammable products or items that are wet with flammable products in, near or on the appliance.
- Do not touch the compressor or the condenser. They are hot.
- Do not share your Wi-Fi password.
- Do not remove or touch items from the freezer compartment if your hands are wet or damp.
- Do not freeze again food that has been thawed.
- Follow the storage instructions on the packaging of frozen food.
- Wrap the food in any food contact material before putting it in the freezer compartment.

## 2.4 Internal lighting

**WARNING!**

Risk of electric shock.

- Concerning the lamp(s) inside this product and spare part lamps sold separately: These lamps are intended to withstand extreme physical conditions in household appliances, such as temperature, vibration, humidity, or are intended to signal information about the operational status of the appliance. They are not intended to be used in other applications and are not suitable for household room illumination.

## 2.5 Care and cleaning

**WARNING!**

Risk of injury or damage to the appliance.

- Before maintenance, deactivate the appliance and disconnect the mains plug from the mains socket.
- This appliance contains hydrocarbons in the cooling unit. Only a qualified person must do the maintenance and the recharging of the unit.
- Regularly examine the drain of the appliance and if necessary, clean it. If the drain is blocked, defrosted water

collects in the bottom of the appliance.

## 2.6 Service

- To repair the appliance contact the Authorised Service Centre. Use original spare parts only.
- Please note that self-repair or non-professional repair can have safety consequences and might void the guarantee.
- The following spare parts will be available for 7 years after the model has been discontinued: thermostats, temperature sensors, printed circuit boards, light sources, door handles, door hinges, trays and baskets. Please note that some of these spare parts are only available to professional repairers, and that not all spare parts are relevant for all models.
- Door gaskets will be available for 10 years after the model has been discontinued.

## 2.7 Disposal



### **WARNING!**

Risk of injury or suffocation.

- Disconnect the appliance from the mains supply.
- Cut off the mains cable and discard it.
- Remove the door to prevent children and pets to be closed inside of the appliance.
- The refrigerant circuit and the insulation materials of this appliance are ozone-friendly.
- The insulation foam contains flammable gas. Contact your municipal authority for information on how to discard the appliance correctly.
- Do not cause damage to the part of the cooling unit that is near the heat exchanger.

# 3. INSTALLATION



### **WARNING!**

Refer to Safety chapters.

### 3.1 Dimensions

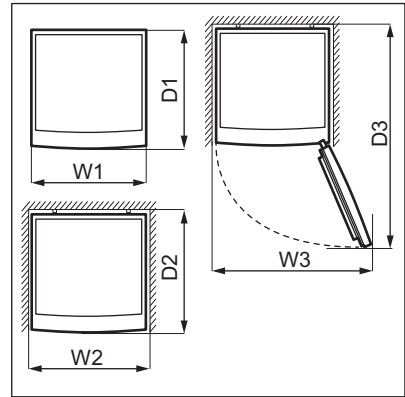
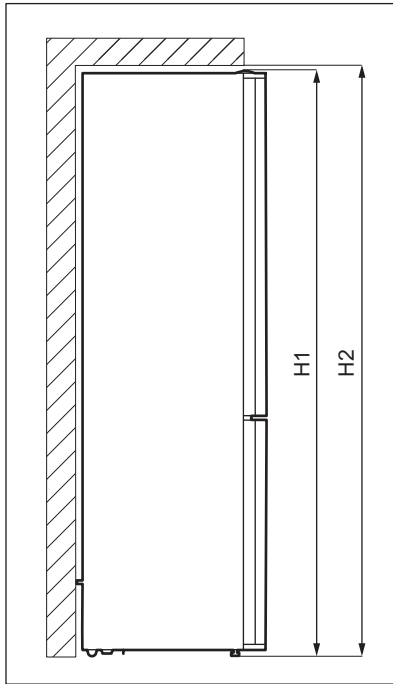

Overall dimensions <sup>1</sup>		
H1*	mm	2010
W1	mm	595
D1	mm	650

<sup>1</sup> the height, width and depth of the appliance without the handle

\* including the height of the top hinge (10 mm)

Space required in use <sup>2</sup>		
H2	mm	2050
W2	mm	600
D2	mm	718

<sup>2</sup> the height, width and depth of the appliance including the handle, plus the space necessary for free circulation of the cooling air

Overall space required in use <sup>3</sup>		
H2	mm	2050
W3	mm	913
D3	mm	1158

<sup>3</sup> the height, width and depth of the appliance including the handle, plus the space necessary for free circulation of the cooling air, plus the space necessary to allow door opening to the minimum angle permitting removal of all internal equipment

### 3.2 Location

This appliance is not intended to be used as a built-in appliance.

In case of different installation from freestanding respecting space required in use dimensions, the appliance will function correctly but energy consumption might increase slightly.



To ensure appliance's best functionality, you should not install the appliance in the nearby of the heat source (oven, stoves, radiators, cookers or hobs) or in a place with direct sunlight. Make sure that air can circulate freely around the back of the cabinet.

This appliance should be installed in a dry, well ventilated indoor position.

To ensure best performance, if the appliance is positioned below an overhanging wall unit, the minimum distance between the top of the cabinet shall be maintained. Ideally, however, the appliance should not be positioned below overhanging wall units. One or more adjustable feet at the base of the cabinet ensure that the appliance stands level.



#### **CAUTION!**

If you position the appliance against the wall, use back spacers provided or keep the minimum distance indicated in the installation instructions.



#### **CAUTION!**

If you install the appliance next to a wall, refer to the installation instructions to understand the minimum distance between the wall and the side of the appliance where door hinges are to provide enough space to open the door when the internal equipment is removed (e.g. when cleaning).

This appliance is intended to be used at ambient temperature ranging from 10°C to 43°C.



The correct operation of the appliance can only be guaranteed within the specified temperature range.



If you have any doubts regarding where to install the appliance, please turn to the vendor, to our customer service or to the nearest Authorised Service Centre.



It must be possible to disconnect the appliance from the mains power supply. The plug must therefore be easily accessible after installation.

### 3.3 Electrical connection

- Before plugging in, ensure that the voltage and frequency shown on the rating plate correspond to your domestic power supply.
- The appliance must be earthed. The power supply cable plug is provided with a contact for this purpose. If the domestic power supply socket is not earthed, connect the appliance to a separate earth in compliance with current regulations, consulting a qualified electrician.
- The manufacturer declines all responsibility if the above safety precautions are not observed.
- This appliance complies with the E.E.C. Directives.

### 3.4 Levelling

When placing the appliance make sure that it stands level. This can be achieved by two adjustable feet at the bottom in front.

### 3.5 Rear spacers

In the bag with the documentation, there are two spacers which must be fitted as shown in the figure.

If you position the appliance against a wall in a freestanding installation, install the rear spacers in order to guarantee the maximum possible distance.

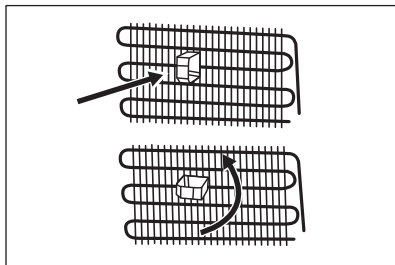

### 3.6 Door reversibility

Please refer to the separate document with instructions on installation and door reversal.



**CAUTION!**  
At every stage of reversing the door protect the floor from scratching with a durable material.

## 4. OPERATION

### 4.1 Control panel

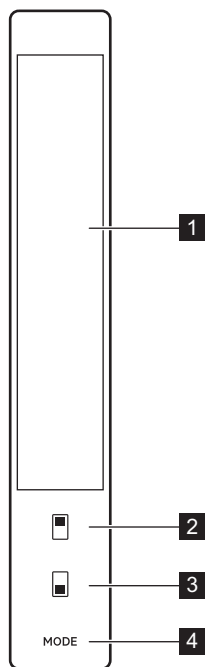

- 1 Display
- 2 Fridge compartment control button
- 3 Freezer compartment control button
- 4 Mode button

## 4.2 Display

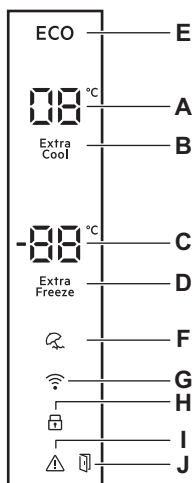

- A. Fridge compartment temperature indicator
- B. Extra Cool indicator
- C. Freezer compartment temperature indicator
- D. Extra Freeze indicator
- E. Economy indicator
- F. Holiday indicator
- G. Wi-Fi indicator
- H. ChildLock indicator
- I. Alarm indicator
- J. Door open alarm indicator

## 4.3 Switching on and off

To switch on the appliance, insert the plug into the wall socket.

- i** When the appliance is switched on for the first time, the interior light may turn on after a one-minute delay due to opening tests.

To switch off the appliance, unplug it.

## 4.4 Temperature regulation

Recommended set temperature is:

- +4°C for the fridge.
- -18°C for the freezer.

The temperature range may vary between -16°C and -24°C or 2°C and 8°C.

To set the temperature of the appliance, press the temperature regulation button repeatedly until you reach the desired temperature of the compartment.

Choose the setting keeping in mind that the temperature inside the appliance depends on:

- room temperature,
- frequency of opening the door,
- quantity of food stored,

- appliance location.

A medium setting is generally the most suitable one.

The temperature indicators show the set temperature.

- i** The set temperature will be reached within 24 hours.

## 4.5 Extra Cool function

If you need to insert a large amount of food at ambient temperature into the fridge compartment, for example after doing the grocery shopping, we suggest activating the Extra Cool function to cool the products more rapidly and to avoid warming another food which is already in the compartment.

To activate this function, press and hold the fridge compartment control button until the Extra Cool indicator appears and the sound is on.

During this mode:

- Temperature of the freezer compartment may be adjusted.
- The Extra Freeze function can be selected.
- The Economy mode can not be selected.

- The Holiday mode can not be selected.

This function stops automatically after a maximum of 5 hours or when the sensor reaches the lowest temperature for the fridge compartment (1-3°C).

You can deactivate the Extra Cool function before its automatic end by repeating the procedure until the Extra Cool indicator turns off or by selecting a different temperature of the fridge compartment.

## 4.6 Extra Freeze function

The Extra Freeze function is used to perform pre-freezing and fast freezing in sequence of freezer compartment. It accelerates the freezing of fresh food and, at the same time, protects foodstuffs already stored from undesirable warming.



To freeze fresh food activate the Extra Freeze function at least 3 hours before placing the food to complete pre-freezing.

To activate this function, press and hold the freezer compartment control button until the Extra Freeze indicator appears and the sound is on.

During this mode:

- Temperature of the fridge compartment may be adjusted.
- The Extra Cool function can be selected.
- The Economy mode can not be selected.
- The Holiday mode can not be selected.

This function stops automatically after 24 hours.

You can deactivate the Extra Freeze function before its automatic end by repeating the procedure until the Extra Freeze indicator turns off or by selecting a different temperature of the freezer compartment.

## 4.7 Economy mode

The Economy mode ensures good food preservation with minimal energy consumption. This is the best setting during periods of non-operation.

To activate this function, press the Mode button until the Economy indicator appears and the sound is on.

During this mode:

- Fridge and freezer compartment temperature indicators show "E".
- The temperature of the fridge and freezer compartments may be adjusted. When the Economy mode is cancelled, the selected temperature values will proceed.



To activate the Holiday mode, cancel the Economy mode first.

You can deactivate the Economy mode by:

- pressing the Mode button.
- activating the Extra Freeze function. The Economy mode is automatically cancelled and the selected function is activated.
- activating the Extra Cool function. The Economy mode is automatically cancelled and the selected function is activated.

## 4.8 Holiday mode

The Holiday mode allows you to keep the fridge compartment empty during a long holiday period reducing the formation of bad odours while the freezer compartment can work normally.

To activate this function, press the Mode button until the Holiday indicator appears and the sound is on.

During this mode:

- Fridge compartment temperature indicator shows "- -".
- The temperature of the fridge and freezer compartments may be adjusted. When the Holiday mode is cancelled, the selected temperature values proceed.

-  To activate the Economy mode, cancel the Holiday mode first.

You can deactivate the Holiday mode by:

- pressing the Mode button.
- activating the Extra Freeze function. The Holiday mode is automatically cancelled and the selected function is activated.
- activating the Extra Cool function. The Holiday mode is automatically cancelled and the selected function is activated.

## 4.9 ChildLock function

Activate the ChildLock function to lock the buttons from unintentional operation.

To activate this function, press and hold the fridge and freezer compartment control buttons simultaneously for 5 seconds.

You can deactivate the ChildLock function by repeating the procedure.

-  The ChildLock function will be deactivated if electricity is interrupted or the appliance is unplugged.

## 4.10 DrinksChill function

The DrinksChill function is to be used to set an acoustic alarm at the preferred time, useful for example when a recipe requires to cool down food products for a certain period of time.

To activate this function:

1. Press the freezer compartment control button for 3 seconds, until the fridge compartment temperature indicator shows "05" (5 minutes).
2. Press the fridge compartment control button to adjust the time from 5 to 30 minutes.

After selected the preferred time, the fridge compartment temperature indicator flashes and an audible alarm sounds.

You can deactivate the DrinksChill function by pressing the freezer compartment control button for 3 seconds.

## 4.11 Screen Saver mode

The Screen Saver mode saves energy by switching off all control panel's indicators when it is left inactive.

To activate this function, press and hold the Mode button for 3 seconds. Then, if no button is pressed within 30 seconds, the indicators on the control panel turn off. The Screen Saver mode is on.

You can operate your appliance during the Screen Saver mode by pressing any button. The current settings appear on the screen and you can make adjustments. After 30 seconds, the control panel turns off again.

-  The ChildLock function may be activated during the Screen Saver mode. You can deactivate the ChildLock function when the control panel's indicators are switch on.

You can deactivate the Screen Saver function by pressing the Mode button for 3 seconds.

## 4.12 Door open alarm

If the fridge or the freezer door is left open for approximately 2 minutes, the sound is on and the alarm indicator flashes.

The alarm stops after closing the door.

# 5. WI-FI CONNECTIVITY SETUP

## 5.1 Wireless connection

This functionality allows you to connect your appliance to Wi-Fi network and to link it to your mobile device.

To connect the appliance you need:

- Wireless network with the Internet connection,
- Mobile device connected to your wireless network.

Frequency	2.412 - 2.472 GHz
Protocol	IEEE 802.11 b/g/n

Take the following steps to onboard the appliance to Wi-Fi:

1. Download the My Electrolux Kitchen app on your mobile device from Google Play (Android) or App Store (iOS).
2. Open the app and register to create an account.
3. Click the + icon in My Appliances view.

4. Select: Classic Provisioning.
5. Plug the appliance into the power socket.
6. Press and hold the Mode button on your appliance for 3 seconds until the sound is on. The Wi-Fi indicator flashes.
7. Follow the instructions in the app to complete the onboarding process.

**i** If you cannot connect to your Wi-Fi refer to "Troubleshooting" chapter.

## 6. DAILY USE

### 6.1 Positioning door shelves

The door of this appliance is equipped with runners that enable shelves/bins to be arranged according to individual preferences.

To reposition the door shelves/bins:

1. Gradually lift the shelf/bin in the direction of the arrows until it comes free.
2. Place the shelf/bin in desired position and gently insert it into the runner.

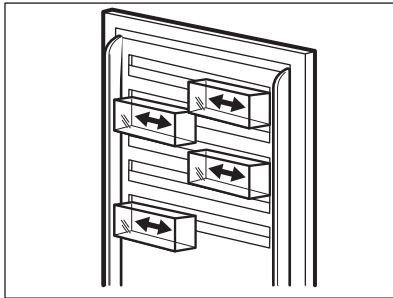

### 6.2 Movable shelves

The walls of the refrigerator compartment are equipped with a series of runners so that the shelves can be positioned as desired.

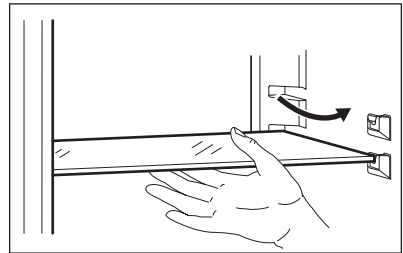

**i** To ensure correct air circulation, do not move the glass shelf above the vegetable drawer.

### 6.3 Extra Chill drawer

The Extra Chill drawer ensures an environment with a lower temperature thanks to the active circulation of cold air and is suitable for the storage of a variety of fresh food (like fish, meat, seafood, lightly pickled food etc.) as it preserves its high nutritional values as well as high humidity level.

The Extra Chill drawer is located in the lower part of the refrigerator, directly above the vegetable drawer.

To remove the drawer:

1. Pull the drawer out until it stops.
2. Once you reach the end of runners, lift slightly the front of the drawer and detach it from the appliance.

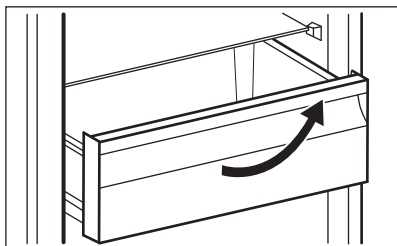

- i** To put the drawer back into its initial position, follow the above steps in reverse order.

## 6.4 Vegetable drawer

There is a special drawer in the bottom part of the appliance suitable for storage of fruits and vegetables.

## 6.5 Removing and installing the freezer drawers

To remove a drawer from the freezer compartment:

1. Open the freezer door completely.
2. Pull the drawer out until it stops.
3. Lift slightly the front of the drawer and detach it from the appliance.

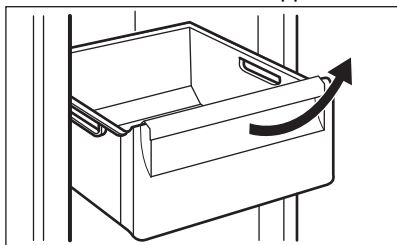

- i** To put the drawer back into its initial position, follow the above steps in reverse order.

## 6.6 Humidity control

The glass shelf incorporates a device with slits (adjustable by means of a sliding lever), which makes it possible to regulate the humidity in the vegetable drawer(s).

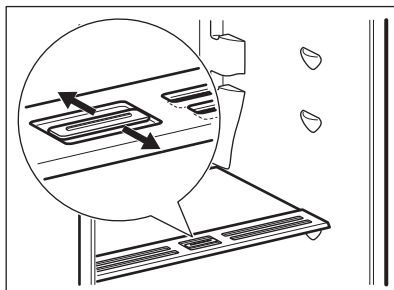

The position of the humidity control depends on the type and on the amount of fruits and vegetables:

- Slots closed: recommended when there is a small amount of fruits and vegetables. In this way, the natural moisture content in fruits and vegetables is preserved longer.
- Slots opened: recommended when there is a big amount of fruits and vegetables. In this way, more air circulation results in a lower air moisture.

## 6.7 Fan

The refrigerator compartment is equipped with a device that allows rapid cooling of food and keeps a more uniform temperature in the compartment.

This device activates automatically when needed.

- i** Do not block the air inlet and outlet openings when storing food, otherwise air circulation provided by the fan will be impaired.

## 6.8 Bottle rack

The refrigerator compartment is equipped with the bottle rack, which enables storing bottled wine or drinks, and it can be taken out to clean.

Place the bottles (with the opening facing front) in the pre-positioned shelf.

- i** Place only closed bottles.

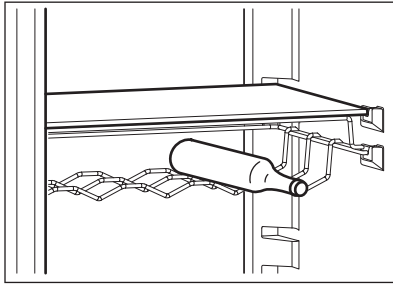

## 6.9 Freezing fresh food

The freezer compartment is suitable for freezing fresh food and storing frozen and deep-frozen food for a long time.

To freeze fresh food activate the Extra Freeze function at least 3 hours before placing the food to be frozen in the freezer compartment.

Store the fresh food evenly distributed in the first and second compartment or drawer from the top.

The maximum amount of food that can be frozen without adding other fresh food during 24 hours is specified on the rating plate (a label located inside the appliance).

## 6.10 Storage of frozen food

When activating an appliance for the first time or after a period out of use, before putting the products in the compartment let the appliance run at least 3 hours with the Extra Freeze function switched on.

# 7. HINTS AND TIPS

## 7.1 Hints for energy saving

- Freezer: The internal configuration of the appliance is the one that ensures the most efficient use of energy.
- Fridge: Most efficient use of energy is ensured in the configuration with the drawers in the bottom part of the appliance and shelves evenly distributed. Position of the door bins does not affect energy consumption.
- Do not open the door frequently or leave it open longer than necessary.

Keep the food no closer than 15 mm from the door.



### CAUTION!

In the event of accidental defrosting, for example due to a power failure, if the power has been off for longer than the value shown on rating plate under "rising time", the defrosted food must be consumed quickly or cooked immediately then cooled and then re-frozen.

## 6.11 Thawing

Deep-frozen or frozen food, prior to being used, can be thawed in the refrigerator compartment or at room temperature, depending on the time available for this operation.

Small pieces may even be cooked still frozen, directly from the freezer: in this case, cooking will take longer.

## 6.12 Ice-cube tray

This appliance is equipped with one or more trays for the production of ice-cubes.



Do not use metallic instruments to remove the trays from the freezer compartment.

1. Fill the ice-cube trays with water.
2. Put them in the freezer compartment.

- Freezer: The colder the temperature setting, the higher the energy consumption.
- Fridge: Do not set too high temperature to save energy unless it is required by the characteristics of the food.
- If the ambient temperature is high and the temperature control is set to low temperature and the appliance is fully loaded, the compressor may run continuously, causing frost or ice formation on the evaporator. In this case, set the temperature control toward higher temperature to allow



automatic defrosting and to save energy this way.

- Ensure a good ventilation. Do not cover the ventilation grilles or holes.
- Make sure that food products inside the appliance allow air circulation through dedicated holes in the rear interior of the appliance.

## 7.2 Hints for freezing

- Activate Extra Freeze function at least 3 hours before placing the food inside the freezer compartment.
- Before freezing wrap and seal fresh food in: aluminium foil, plastic film or bags, airtight containers with lid.
- For more efficient freezing and thawing divide food into small portions.
- It is recommended to put labels and dates on all your frozen food. This will help to identify foods and to know when they should be used before their deterioration.
- The food should be fresh when being frozen to preserve good quality. Especially fruits and vegetables should be frozen after the harvest to preserve all of their nutrients.
- Do not freeze bottles or cans with liquids, in particular drinks containing carbon dioxide - they may explode during freezing.
- Do not put hot food in the freezer compartment. Cool it down at room temperature before placing it inside the compartment.
- To avoid increase in temperature of already frozen food, do not place fresh unfrozen food directly next to it. Place food at room temperature in the part of the freezer compartment where there is no frozen food.
- Do not eat ice cubes, water ices or ice lollies immediately after taking them out of the freezer. Risk of frostbites.
- Do not re-freeze defrosted food. If the food has defrosted, cook it, cool it down and then freeze it.

## 7.3 Hints for storage of frozen food

- Freezer compartment is the one marked with .
- Good temperature setting that ensures preservation of frozen food products is a temperature less than or equal to -18°C. Higher temperature setting inside the appliance may lead to shorter shelf life.
- The whole freezer compartment is suitable for storage of frozen food products.
- Leave enough space around the food to allow air to circulate freely.
- For adequate storage refer to food packaging label to see the shelf life of food.
- It is important to wrap the food in such a way that prevents water, humidity or condensation from getting inside.

## 7.4 Shopping tips

After grocery shopping:

- Ensure that the packaging is not damaged - the food could be deteriorated. If the package is swollen or wet, it might have not been stored in the optimal conditions and defrosting may have already started.
- To limit the defrosting process buy frozen goods at the end of your grocery shopping and transport them in a thermal and insulated cool bag.
- Place the frozen foods immediately in the freezer after coming back from the shop.
- If food has defrosted even partially, do not re-freeze it. Consume it as soon as possible.
- Respect the expiry date and the storage information on the package.

## 7.5 Shelf life for freezer compartment

Type of food	Shelf life (months)
Bread	3
Fruits (except citrus)	6 - 12
Vegetables	8 - 10
Leftovers without meat	1 - 2
<b>Dairy food:</b>	
Butter	6 - 9
Soft cheese (e.g. mozzarella)	3 - 4
Hard cheese (e.g. parmesan, cheddar)	6
<b>Seafood:</b>	
Fatty fish (e.g. salmon, mackerel)	2 - 3
Lean fish (e.g. cod, flounder)	4 - 6
Shrimps	12
Shucked clams and mussels	3 - 4
Cooked fish	1 - 2
<b>Meat:</b>	
Poultry	9 - 12
Beef	6 - 12
Pork	4 - 6
Lamb	6 - 9
Sausage	1 - 2
Ham	1 - 2
Leftovers with meat	2 - 3

## 7.6 Hints for fresh food refrigeration

- Good temperature setting that ensures preservation of fresh food is a temperature less than or equal to +4°C.  
Higher temperature setting inside the appliance may lead to shorter shelf life of food.
- Cover the food with packaging to preserve its freshness and aroma.
- Always use closed containers for liquids and for food, to avoid flavours or odours in the compartment.
- To avoid the cross-contamination between cooked and raw food, cover the cooked food and separate it from the raw one.
- It is recommended to defrost the food inside the fridge.
- Do not insert hot food inside the appliance. Make sure it has cooled

down at room temperature before inserting it.

- To prevent food waste the new stock of food should always be placed behind the old one.

## 7.7 Hints for food refrigeration

- Fresh food compartment is the one marked (on the rating plate) with .
- Meat (all types): wrap in a suitable packaging and place it on the glass shelf above the vegetable drawer. Store meat for at most 1-2 days.
- Fruit and vegetables: clean thoroughly (eliminate the soil) and place in a special drawer (vegetable drawer).
- It is advisable not to keep the exotic fruits like bananas, mangos, papayas etc. in the refrigerator.
- Vegetables like tomatoes, potatoes, onions, and garlic should not be kept in the refrigerator.

- Butter and cheese: place in an airtight container or wrap in an aluminium foil or a polythene bag to exclude as much air as possible.
- Bottles: close them with a cap and place them on the door bottle shelf, or (if available) on the bottle rack.
- Always refer to the expiry date of the products to know how long to keep them.

## 8. CARE AND CLEANING



### WARNING!

Refer to Safety chapters.

### 8.1 Cleaning the interior

Before using the appliance for the first time, the interior and all internal accessories should be washed with lukewarm water and some neutral soap to remove the typical smell of a brand-new product, then dried thoroughly.



### CAUTION!

Do not use detergents, abrasive powders, chlorine or oil-based cleaners as they will damage the finish.



### CAUTION!

The accessories and parts of the appliance are not suitable for washing in a dishwasher.

### 8.2 Periodic cleaning

The equipment has to be cleaned regularly:

1. Clean the inside and accessories with lukewarm water and some neutral soap.

2. Regularly check the door seals and wipe them clean to ensure they are clean and free from debris.
3. Clean the condenser with a brush at least twice a year.
4. Rinse and dry thoroughly.

### 8.3 Defrosting of the appliance

Frost is automatically eliminated from the evaporator of the refrigerator compartment every time the motor compressor stops, during normal use. The defrost water drains out through a trough into a special container at the back of the appliance, over the motor compressor, where it evaporates.

### 8.4 Periods of non-operation

When the appliance is not in use for long periods, take the following precautions:

1. Disconnect the appliance from electricity supply.
2. Remove all food.
3. Clean the appliance and all accessories.
4. Leave the doors open to prevent unpleasant smells.

## 9. TROUBLESHOOTING



### WARNING!

Refer to Safety chapters.

### 9.1 Error Codes



### WARNING!

Deactivate the appliance before carrying out any check.

Warning codes are shown on the display.

Error type	Possible cause	Solution
E01 - E07		Contact the nearest Authorized Service Centre.
E08	Power supply to the device has dropped to below 170 V.	The voltage needs to be increased back to required levels.
E10	Fridge compartment is not cold enough.	Set a colder temperature in the fridge compartment.
E11	Fridge compartment is too cold.	<ul style="list-style-type: none"> <li>• Switch off Extra Cool function.</li> <li>• Set a higher temperature in the fridge compartment.</li> <li>• Make sure that ventilation holes are clear and not clogged.</li> </ul>



If the problems continue, contact the Authorized Service Centre.

In case of different problem with the appliance, check the table below for possible solutions.

## 9.2 What to do if...

Problem	Possible cause	Solution
The appliance does not operate.	The appliance is switched off.	Switch on the appliance.
	The mains plug is not connected to the mains socket correctly.	Connect the mains plug to the mains socket correctly.
	There is no voltage in the mains socket.	Connect a different electrical appliance to the mains socket. Contact a qualified electrician.
The appliance is noisy.	The appliance is not supported properly.	Check if the appliance stands stable.
The compressor operates continually.	Temperature is set incorrectly.	Refer to "Operation" chapter.
	Many food products were put in at the same time.	Wait a few hours and then check the temperature again.
	The room temperature is too high.	Refer to "Installation" chapter.
	Food products placed in the appliance were too warm.	Allow food products to cool to room temperature before storing.

<b>Problem</b>	<b>Possible cause</b>	<b>Solution</b>
	The door is not closed correctly.	Refer to "Closing the door" section.
	The Extra Freeze function is switched on.	Refer to "Extra Freeze function" section.
The compressor does not start immediately after pressing the "Extra Freeze", or after changing the temperature.	The compressor starts after a period of time.	This is normal, no error has occurred.
Door is misaligned or interferes with ventilation grill.	The appliance is not levelled.	Refer to installation instructions.
Door does not open easily.	You attempted to re-open the door immediately after closing.	Wait a few seconds between closing and re-opening of the door.
The lamp does not work.	The lamp is in stand-by mode.	Close and open the door.
	The lamp is defective.	Contact the nearest Authorized Service Centre.
There is too much frost and ice.	The door is not closed correctly.	Refer to "Closing the door" section.
	The gasket is deformed or dirty.	Refer to "Closing the door" section.
	Food products are not wrapped properly.	Wrap the food products better.
	Temperature is set incorrectly.	Refer to "Operation" chapter.
	Appliance is fully loaded and is set to the lowest temperature.	Set a higher temperature. Refer to "Operation" chapter.
	Temperature set in the appliance is too low and the ambient temperature is too high.	Set a higher temperature. Refer to "Operation" chapter.
Water flows on the rear plate of the refrigerator.	During the automatic defrosting process, frost melts on the rear plate.	This is correct. Dry the water with a soft cloth.
There is too much condensed water on the rear wall of the refrigerator.	Door was opened too frequently.	Open the door only when necessary.
	Door was not closed completely.	Make sure the door is closed completely.

<b>Problem</b>	<b>Possible cause</b>	<b>Solution</b>
	Stored food was not wrapped.	Wrap food in suitable packaging before storing it in the appliance.
Water flows on the floor.	The melting water outlet is not connected to the evaporative tray above the compressor.	Attach the melting water outlet to the evaporative tray.
Temperature cannot be set.	The Extra Freeze function is switched on.	Switch off the Extra Freeze function manually, or wait until the function deactivates automatically to set the temperature. Refer to "Extra Freeze function" section.
The temperature in the appliance is too low/too high.	The temperature is not set correctly.	Set a higher/lower temperature.
	The door is not closed correctly.	Refer to "Closing the door" section.
	The food products' temperature is too high.	Let the food products temperature decrease to room temperature before storage.
	Many food products are stored at the same time.	Store less food products at the same time.
	The door has been opened often.	Open the door only if necessary.
	The Extra Freeze function is switched on.	Refer to "Extra Freeze function" section.
	There is no cold air circulation in the appliance.	Make sure that there is cold air circulation in the appliance. Refer to "Hints and Tips" chapter.
The WiFi does not connect with the appliance, the WiFi indicator blinks.	The WiFi router does not work.	Check whether the router is ON and if other connected devices are working. If the router was OFF, turn it ON, wait for a few minutes and check again.
	The router needs a restart.	Restart the router by unplugging and plugging it. Wait a few minutes and check again.

Problem	Possible cause	Solution
	Your connected appliance needs a Wi-Fi reset.	Reset the Wi-Fi connection by pressing and holding for 10 seconds Control Panel's Freezer compartment control and Mode buttons. Wait a few minutes and connect again. Refer to the "Wi-Fi Connectivity Setup" chapter.
	Your appliance is out of range from the router.	Make sure your appliance is within 10 metres range from your router and with not too many walls in between.
		Connect your appliance to the 2,4 GHz band on your WiFi router when onboarding instead of the 5 GHz band. This will give a stronger and longer range signal.



If the advice does not lead to the desired result, call the nearest Authorized Service Centre.

### 9.3 Replacing the lamp

The appliance is equipped with a longlife LED interior light.

Only service is allowed to replace the lighting device. Contact your Authorised Service Centre.

### 9.4 Closing the door

1. Clean the door gaskets.
2. If necessary, adjust the door. Refer to "Installation" chapter.
3. If necessary, replace the defective door gaskets. Contact the Authorised Service Centre.

## 10. NOISES

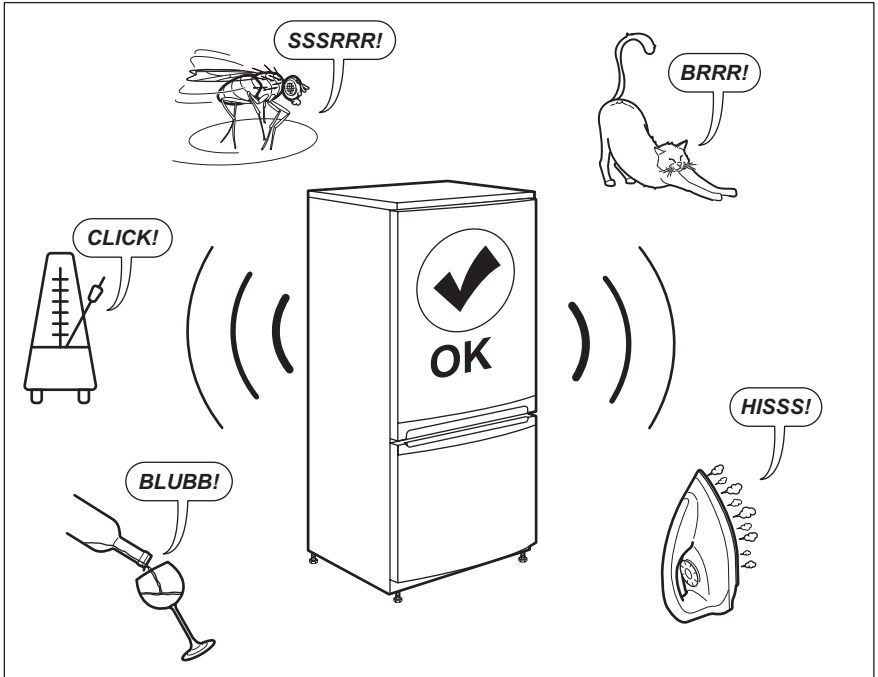

## 11. TECHNICAL DATA

The technical information is situated in the rating plate on the internal side of the appliance and on the energy label.

The QR code on the energy label supplied with the appliance provides a web link to the information related to the performance of the appliance in the EU EPREL database. Keep the energy label for reference together with the user manual and all other documents provided with this appliance.

It is also possible to find the same information in EPREL using the link <https://eprel.ec.europa.eu> and the model name and product number that you find on the rating plate of the appliance.

See the link [www.theenergylabel.eu](http://www.theenergylabel.eu) for detailed information about the energy label.

## 12. INFORMATION FOR TEST INSTITUTES

Installation and preparation of the appliance for any EcoDesign verification shall be compliant with EN 62552. Ventilation requirements, recess dimensions and minimum rear

clearances shall be as stated in this User Manual at Chapter 3. Please contact the manufacturer for any other further information, including loading plans.



## 13. ENVIRONMENTAL CONCERNS

Recycle materials with the symbol . Put the packaging in relevant containers to recycle it. Help protect the environment and human health by recycling waste of electrical and electronic appliances. Do not dispose of

appliances marked with the symbol  with the household waste. Return the product to your local recycling facility or contact your municipal office.





www.electrolux.com/shop



804183163-A-262021

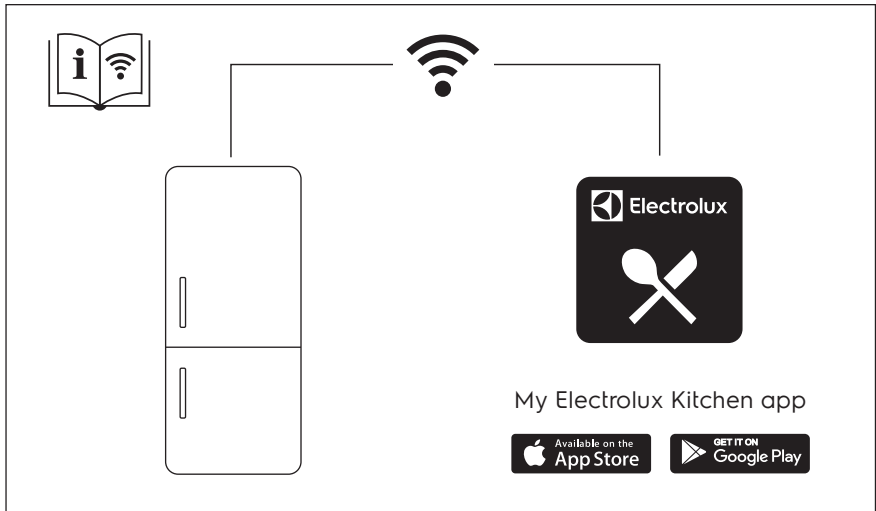

The software in this product contains components that are based on free and open source software. Electrolux gratefully acknowledges the contributions of the open software and robotics communities to the development project.

To access the source code of these free and open source software components whose license conditions require publishing, and to see their full copyright information and applicable license terms, please visit: <http://electrolux.opensoftwarerepository.com> (folder NIU5)